

INSTALLATION INSTRUCTIONS: MCD DEVICENET MODULE

Order Code: 175G9002

1. Installation

Install the DeviceNet Module using the following procedure:

1. Remove control power and mains supply from the soft starter.
2. Attach the DeviceNet Module to the soft starter as illustrated below.
3. Set the DeviceNet Module Node Address (MAC ID) and Data Rate.
4. Apply control power to the soft starter.
5. Insert the network connector into the module and power up the DeviceNet network.

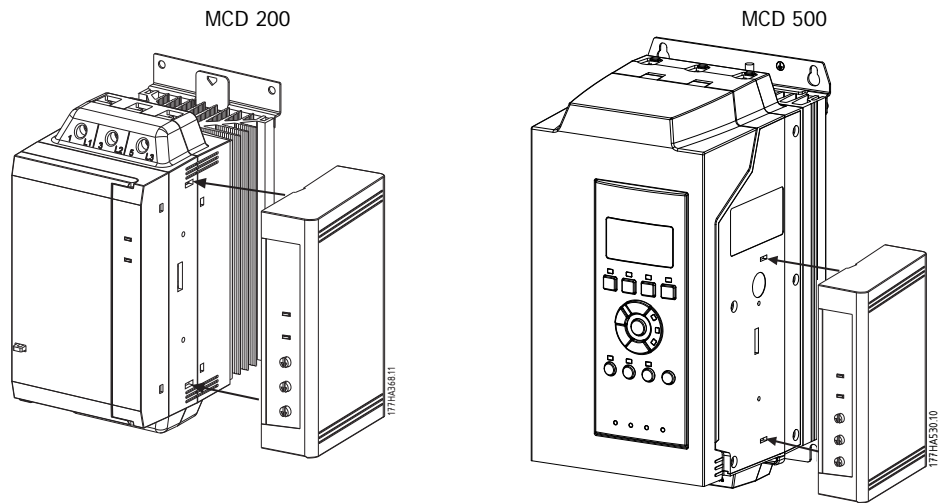

CAUTION

Network designs must decrease the maximum allowable cumulative dropline length by 400 mm for every DeviceNet Module installed on the network. Failure to do so may result in network communication errors and decreased reliability.

Example: ODVA specifies a maximum cumulative dropline length of 156 m on a network operating at 125 kb/s. If six DeviceNet Modules were installed on this network, the total cumulative dropline length would need to be decreased to 153.6 m.

Remove the DeviceNet Module using the following procedure:

1. Take the module off-line and remove the DeviceNet connector.
2. Remove control power and mains supply from the soft starter.
3. Push a small flat-bladed screwdriver into the slots at the top and bottom of the module and depress the retaining clips.
4. Pull the module away from the soft starter.

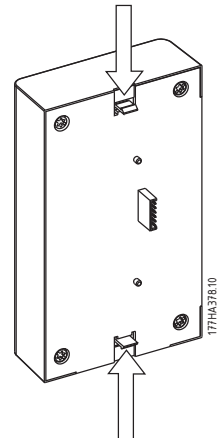

CAUTION

Remove mains and control voltage from the soft starter before attaching or removing accessories. Failure to do so may damage the equipment.

2. Configuration

The DeviceNet Module is a Group 2 slave device, using a predefined master/slave connection set. I/O data is produced and consumed using polled I/O messaging.

The soft starter must be added to the DeviceNet manager project using the EDS file and configuration/management software tool. This file is available on the supplied CD or can be downloaded from the website www.danfoss.com/drives. In order to operate successfully, the correct EDS file must be used.

Product	EDS Filename
MCD 200	SSDM04_11.eds
MCD 500	SSDM07_12_1.eds (serial number version xxxx03-xxx or earlier)
	SSDM07_13_1.eds (serial number version xxxx04-xxx)

An on-screen graphics bitmap file (device.bmp) is available on the supplied CD or can be downloaded from the website www.danfoss.com/drives.

3. Adjustment

The factory default settings for the rotary adjustment switches are:

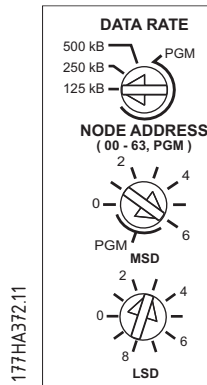

Changes to the rotary switch settings take effect when the DeviceNet network is next powered up.



N.B.!:

The Data Rate and Node Address (MAC ID) must be set locally on the module. These cannot be set using DeviceNet management software.

When the Data Rate and MSD Node Address (MAC ID) rotary switches are set on PGM position, the module uses the previously used valid on-line Data Rate and Node Address (MAC ID).

4. Connection

For the DeviceNet Module to accept serial commands, a link must be fitted across terminals A1-N2 on MCD 200 starters.

In order for the MCD 500 to accept commands from the serial network, the soft starter must be in Auto On mode and links must be fitted to terminals 17 and 25 to 18.

In Hand On mode, the starter will not accept commands from the serial network but the starter's status can still be monitored.

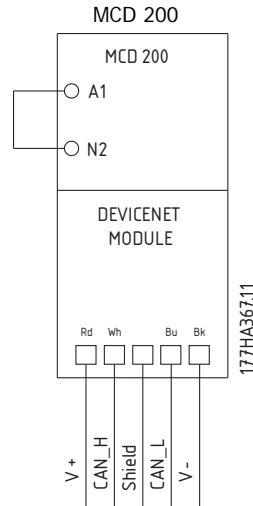

Standard connection onto DeviceNet bus

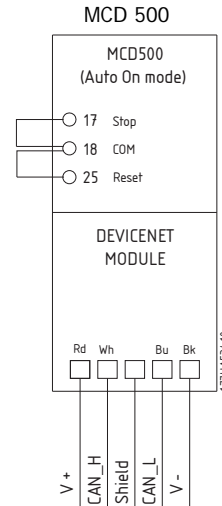

Standard connection onto DeviceNet bus



N.B.!:

If parameter 3-2 *Comms in Remote* is set to Disable Comms in Remote, the starter will not accept start or stop commands from the serial network (the starter will still accept reset commands and allow status monitoring).

5. Module and Network LEDs

The Module LED indicates the condition of the power supply and module operation.

The Network LED indicates status of the communication link between the DeviceNet Module and the network Master. LED operation is as follows:

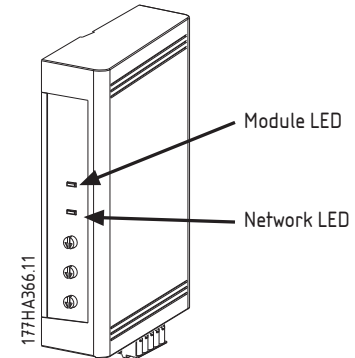

LED	State	Description
Module	Off	Network power off
	Green	Normal operation
	Red	Unrecoverable fault
	Red/Green flashing	Self Test mode
Network	Off	Duplicate MAC ID test has not been completed
	Green flashing	Online but no connection with Master
	Green	Online and allocated to a Master
	Red flashing	One or more timed out I/O connections
	Red	Failed communication between module and Master
	Red/Green flashing	Communication faulted and received an Identity communication faulted request



N.B.!:

When a communications failure occurs, the soft starter may trip if the Communication Timeout parameter for the network is set greater than zero. When communication is restored, the soft starter must be reset.

6. DeviceNet Polled I/O Structure

Once the EDS file has been loaded, the DeviceNet Module must be added to the scanner list with parameters shown in the following table:

Parameter	Value
I/O connection type	Polled
Poll receive size	14 bytes
Poll transmit size	2 bytes

Once the soft starter, module and Master have been set up, configured and powered up, the Master will transmit 2 bytes of data to the module and receive 14 bytes of data from the module.

Master > Slave polled I/O output data is as follows:

Byte	Bit	Function
0	0	0 = Stop command 1 = Start command
	1	0 = Enable Start or Stop command 1 = Quick Stop (i.e. coast to stop) and disable Start command
	2	0 = Enable Start or Stop command 1 = Reset command and disable Start command
	3 to 7	<i>Reserved</i>
1	0 to 1 ¹	0 = Use soft starter remote input to select motor set 1 = Use primary motor set when starting ² 2 = Use secondary motor set when starting ² 3 = <i>Reserved</i>
	2 to 7	<i>Reserved</i>

¹ Only available on MCD 500 soft starters.

² Ensure that the programmable input is not set to Motor Set Select before using this function.

Slave > Master polled I/O input data is as follows:

Byte	Bit	Function	Value
0	0	Trip	1 = Soft starter trip
	1 ¹	Warning	1 = Soft starter warning
	2	Running	0 = Unknown, not ready, ready to start or tripped 1 = Starting, running, stopping or jogging.
	3	<i>Reserved</i>	
	4	Ready	0 = Start or stop command not acceptable 1 = Start or stop command acceptable
	5	Control from Net	1 = Always except in Program mode
	6	<i>Reserved</i>	
	7	At reference	1 = Running (full voltage at the motor)
1	0 to 7	Status	0 = Unknown (menu open) ¹ 2 = Starter not ready (restart delay, thermal delay or run simulation) ¹ 3 = Ready to start (including warning state ¹) 4 = Starting or running 5 = Soft stopping 7 = Trip 8 = Jog forward ¹ 9 = Jog reverse ¹
2	0 to 7	Trip/Warning code	See trip code table below
3	0	Initialised	1 = Phase sequence bit is valid (bit 1) after 1 st start
	1	Phase sequence	1 = Positive phase sequence detected

	2 to 7	<i>Reserved</i>	
4 ²	0 to 7	Motor current (low byte)	Current (A) ³
5 ²	0 to 7	Motor current (high byte)	
6 ²	0 to 7	Current %FLC (low byte)	Current as a percentage of soft starter FLC setting (%)
7 ²	0 to 7	Current %FLC (high byte)	
8 ²	0 to 7	% Motor temperature	Motor thermal model
9	0 to 7	<i>Reserved</i>	
10 ¹	0 to 7	% Power factor	Percentage power factor (100 = power factor of 1)
11 ¹	0 to 7	Power (low byte)	Power low byte, scaled by power scale
12 ¹	0 to 3	Power (high nibble)	Power high nibble, scaled by power scale
	4 to 5	Power scale	0 = Multiply power by 10 to get W 1 = Multiply power by 100 to get W 2 = Power (kW) 3 = Multiply power by 10 to get kW
	6 to 7	<i>Reserved</i>	
13	0 to 7	<i>Reserved</i>	

¹ Only available on MCD 500 soft starters.

² Only available on MCD 202 and MCD 500 soft starters.

³ For MCD 500 models MCD5-0068B and smaller this value will be 10 times greater than the value displayed on the LCP.

6.1. Trip Codes

Code	Trip Type	MCD 201	MCD 202	MCD 500
0	No trip	■	■	■
11	Input A trip			■
20	Motor overload (thermal model)		■	■
21	Heatsink overtemperature			■
23	L1 phase loss			■
24	L2 phase loss			■
25	L3 phase loss			■
26	Current imbalance		■	■
28	Instantaneous overcurrent			■
29	Undercurrent			■
50	Power loss (Power circuit)	■	■	■
54	Phase sequence		■	■
55	Frequency (Mains Supply)	■	■	■
60	Unsupported option (not available in inside delta)			■
61	FLC too high (FLC out of range)			■
62	EEPROM fail			■
70	Miscellaneous			■
75	Motor thermistor		■	■
101	Excess start time		■	■
102	Motor connection			■
104	Internal fault			■
113	Starter communication (between module and soft starter)	■	■	■
114	Network communication (between module and network)	■	■	■
115	L1-T1 shorted			■
116	L2-T2 shorted			■
117	L3-T3 shorted			■
119	Time-overcurrent (Bypass overload)		■	■
121	Battery/Clock			■
122	Thermistor circuit			■

7. Parameter Object

The DeviceNet Module supports parameter objects through explicit messaging. Soft starter parameters can be uploaded (written) and downloaded (read) using DeviceNet management software. When the DeviceNet Module is powered up, it automatically obtains parameter information from the soft starter.

Detail	Value (Hex)	Comment
Class	0F	Parameter object address
Instance	1 ~ xxx	xxx = maximum soft starter parameter number
Attribute ID	01	Always 0x01
Get Service	0E	Read single soft starter parameter value
Set Service	10	Write single soft starter parameter value



N.B.!:

Only available on MCD 500 soft starters. For parameter details, see the soft starter User Manual.

The numbering of parameter options via serial communications differs slightly from the numbering displayed on the LCP. Numbering via the DeviceNet Module starts at 0, so for Par. 2-1 Phase Sequence, the options are 1~3 on the LCP but 0~2 via the module.

8. Specifications

Enclosure	
Dimensions	35 mm (W) x 157 mm (H) x 90 mm (D)
Weight	250 g
Protection	IP20
Mounting	
Spring-action plastic mounting clips (x 2)	
Connections	
Soft starter	6-way pin assembly
Network	5-way male and unpluggable female connector (supplied)
Maximum cable size	2.5 mm ²
Contacts	Gold flash
Settings	
Node address (MAC ID)	
Setting	Rotary switches
Range	0 to 63 (63, factory default)
Data rate	
Setting	Rotary switch
Options	125 kB, 250 kB, 500 kB (125 kB, factory default)
Power	
Consumption	
steady state	19 mA at 25 VDC
.....	31 mA at 11 VDC
in-rush (at 24 VDC)	1.8 A maximum for 2 ms
Galvanically isolated	
Certification	
C✓	IEC 60947-4-2
CE	IEC 60947-4-2
ODVA	DeviceNet Conformance Tested ®